



V-MAX

CABINET PARTS SECTION



READING A PARTS LIST

- I **ITEM NUMBER** is found in two locations:
 - A. It is on the drawing plate, and identifies the part and its location;
 - B. The same number is in the parts lists and ties the two together.

 - II **PART NUMBER** is the part number that has been assigned to a specific part by Vendo, for easier identification.

 - III **QUANTITY REQUIRED** relates to the amount required of a part, or will be indicated by "A/R" as required to attach it to another part.

 - IV **PART NAME AND DESCRIPTION** is the general description for the part, for easier identification when ordering a like part.

 - V **HARDWARE** is identified by a letter in a hexagon. Refer to hardware list section for description and part numbers. See pages C-4 and C-5.
-

The example below will show how the parts are listed in the parts lists:

1. **VEND MOTOR ASSEMBLY:** This is the main assembly name, and any replaceable parts will be indented below the assembly.

2. **RETAINER CAM:** This is an individual part, and will be indented. These indented parts can be ordered separately, so you do not need to order the entire assembly.

3. Whenever an assembly is ordered, all the parts that are indented will be included in the assembly. Any hardware will be listed next to their corresponding parts.

4. Any parts that may be ordered separately will not have any indented parts listed below them.

"V-MAX" VEND MOTOR ASSEMBLY

ITEM NO.	DESCRIPTION	QTY REQ'D	PART NO.
1	VEND MOTOR ASSEMBLY	-	1115821
2	RETAINER CAM	1	1113244
3	TIMING CAM	1	1113236
4			













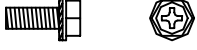

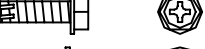
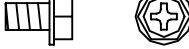

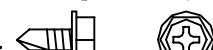
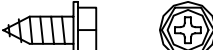
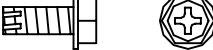
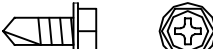

If an asterisk is listed below the parts list, it is an indication that special information is noted. There may be more than one asterisk (*) (**) (***) denoting special notes.





























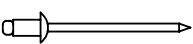

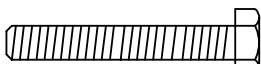







“V-MAX” KIT LIST		
DESCRIPTION	KIT NUMBER	
INNER - OUTER DOOR LOCK	1120520	
S/S SLIDING LOCK POS COVER KIT	1122630	
T-HANDLE LOCK COVER KIT - TRADE	1047795	
T-HANDLE LOCK COVER KIT - COCA-COLA	1047779	
T-HANDLE LOCK COVER KIT - DR PEPPER	1088392	
VENDOR SUPPORT KIT - BLACK BRACKETS	133666	
INNER DOOR GASKET - 72”	1075678	
INNER DOOR GASKET - 79”	1075678-1	
CASTER KIT	133513	
CASTER W/ BRAKE KIT	133513-1	
COIN BOX LOCK	1087759	
HOPPER GUARD (CURVED)	1070538	
HOPPER GUARD (ROBO)	1076082	
UNIQUE FOR V-MAX		
DESCRIPTION	PART NUMBER	QTY REQ
BUCKET	1120146	1
BACK SPACER -72”	1078805	1
BACK SPACER -79”	1078805-1	1
LATCH BRACKET	1079112	1
GAGE BAR	1111651	1
GATE	1121282	1
FLAT SHIM	1078848	A/R
SPACER 0.47	1078872	A/R
SPACER 0.46	1078864	A/R
SPACER 0.37	1122032	A/R
COMMON PARTS V-MAX		
DESCRIPTION	PART NUMBER	QTY REQ
QUICKER LOCK CAP	1111988	1
COINAGE DOOR LATCH	1085546	1
EVAPORATOR FAN MOTOR	42321-17	1
CONDENSER FAN MOTOR	42321-36	1
PRODUCT CLIP (SHORT) - WHITE	1066104	A/R
PRODUCT CLIP (TALL) - BLACK	1066112	A/R
PRODUCT CLIP (MEDIUM) - GRAY	1066112-1	A/R
PRODUCT CLIP (3 RD CAN CLIP) - GRAY	1121704	A/R
PRODUCT CLIP (4 TH CAN CLIP) - BLACK	1122103	A/R



Hardware List

PART NO.	DESCRIPTION	PICTORIAL
A	V800762 #8 X 5/16" TAPPING SCREW	
B	V802139 #8 X 5/8" TAPPING SCREW	
C	V800586 #8 X 3/8" TAPPING SCREW W / LOCK WASHER	
D	V801493 #8 X 1/2" TAPPING SCREW (FOR PLASTIC)	
E	V801475 #8 X 1/2" TAPPING SCREW	
F	V801421 #10 X 5/16" TAPPING SCREW	
G	V800570 #10 X 3/8" TAPPING SCREW	
H	V802047 #10 X 3/8" SCREW	
I	V802141 #10 X 1/2" TAPPING SCREW	
J	V801422 #10 X 1/2" TAPPING SCREW	
K	V801489 #10 X 1/2" SELF DRILLING SCREW	
L	V800512 #10 X 1-3/8" TAPPING SCREW	
M	V802115 #10 X 1" BOLT	
N	V801360 1/4" X 1/2" TAPPING SCREW W / LOCK WASHER	
O	V801343 1/4" X 1" TAPPING SCREW	
P	V801490 1/4" X 1" SELF DRILLING SCREW	
Q	V802053 1/4" X 2-1/4" BOLT	
R	V802069 1/4" X 5/8" CARRIAGE BOLT	
S	V801434 1/4" X 3/4" CARRIAGE BOLT	
T	V800267 1/4" X 3/8" BOLT	
U	V800956 #8 NUT W / LOCK WASHER	
V	V800952 #10 NUT W / LOCK WASHER	



W	V802111	#10 HEX NUT		
X	V802113	#10 LOCK NUT W / NYLON INSERT		
Y	V800959	1/4" NUT W / LOCK WASHER		
Z	387925	1/4" LOCK NUT W / NYLON INSERT		
AA	V802062	3/8" LOCK NUT W / NYLON INSERT		
AB	V801013	#10 FLAT WASHER		
AC	389026	#10 FLAT WASHER, LARGER O.D.		
AD	V801491	3/8" FLAT WASHER		
AE	V801412	1/8" POP RIVET		
AF	43842	CLOSED END CONNECTOR		
AG	V802166	1/2" 13 X 1-1/2" BOLT		
AH	V802165	1/2" LOCK WASHER.....		
AI	V801023	1/2" FLAT WASHER.....		
AJ	V801435	1/4" 20 X 1" CARRIAGE BOLT		
AK	V329258	1/4" X 20 CARRIAGE BOLT.....		
AL	V800140	#10 X 3/8" TAPPING SCREW		
AM	V802173	1/4" X 1/2" TAPPING SCREW		
AN	V802162	1/4" X 1-3/4" SCREW		
AO	V802169	1/4" X 1-3/8" BOLT		

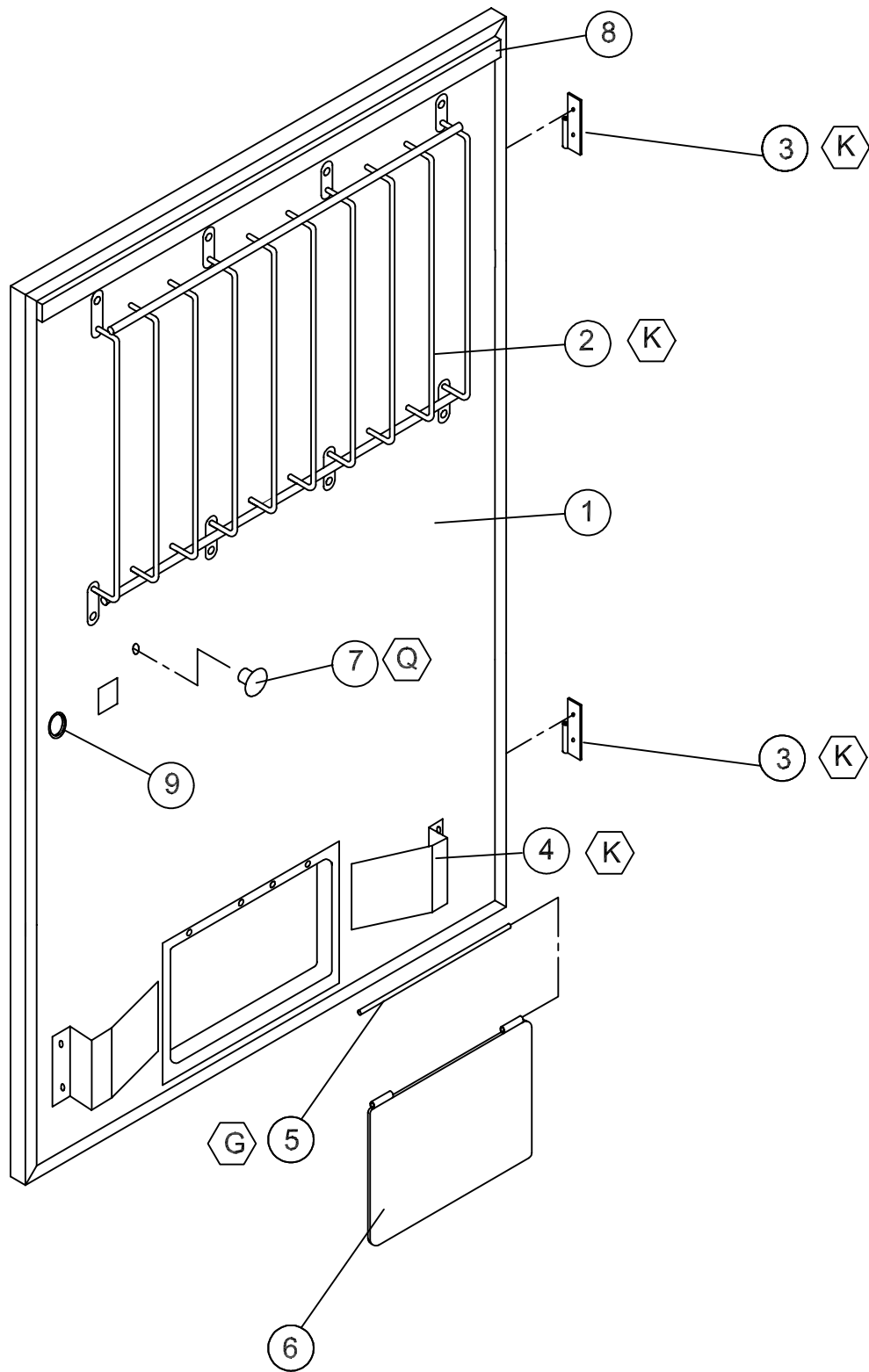



V-MAX INNER DOOR ASSEMBLY

ITEM NO.	MODEL NUMBER		GIV	576	720	840
	DESCRIPTION	QTY REQ	PART NO.	PART NO.	PART NO.	PART NO.
1	INNER DOOR ASSEMBLY (FOAMED)	1	134302-54	134302-53	134302-44	134302-47
2	PROD. RETAINER UPPER	1	1120633-4	1117937	1120633-4	1120633-5
3	HINGE - FEMALE	2	1121286	1121286	1121286	1121286
4	PROD. DEFLECTOR	2	1120129	1120129	1120129	1120129
5	PIN - HINGE	1	389985	389985	389985	389985
6	FLAP - DOOR (REVERSIBLE)	1	1013076	1013076	1013076	1013076
7	KNOB - DOOR	1	388305	388305	388305	388305
8	RAIN SEAL - INNER DOOR	1	1111732-2	1111732-2	1111732-2	1111732-2
9	GROMMET	2	388090	388090	388090	388090
THE FOLLOWING ARE NOT SHOWN						
~	LABEL - PRODUCT SET-UP GUIDE	1	1122196	1122196	1122196	1122196
~	LABEL - 9.2 ERROR CODE MAP	1	1111465	1111465	1111465	1111465
~	LABEL - PROGRAMMING VEC 9.2	1	1111244	1111244	1111244	1111244
~	LABEL - WIRING DIAGRAM VEC 9.2	1	1122839	1122839	1122839	1122839
~	LABEL - WARNING	1	1008323-1	1008323-1	1008323-1	1008323-1
~	LABEL - CONFIGURATION MAP	1	1111457	1111457	1111457	1111457
~	LABEL - SPACE TO SALES	1	1123367	1123367	1123367	1123367

1

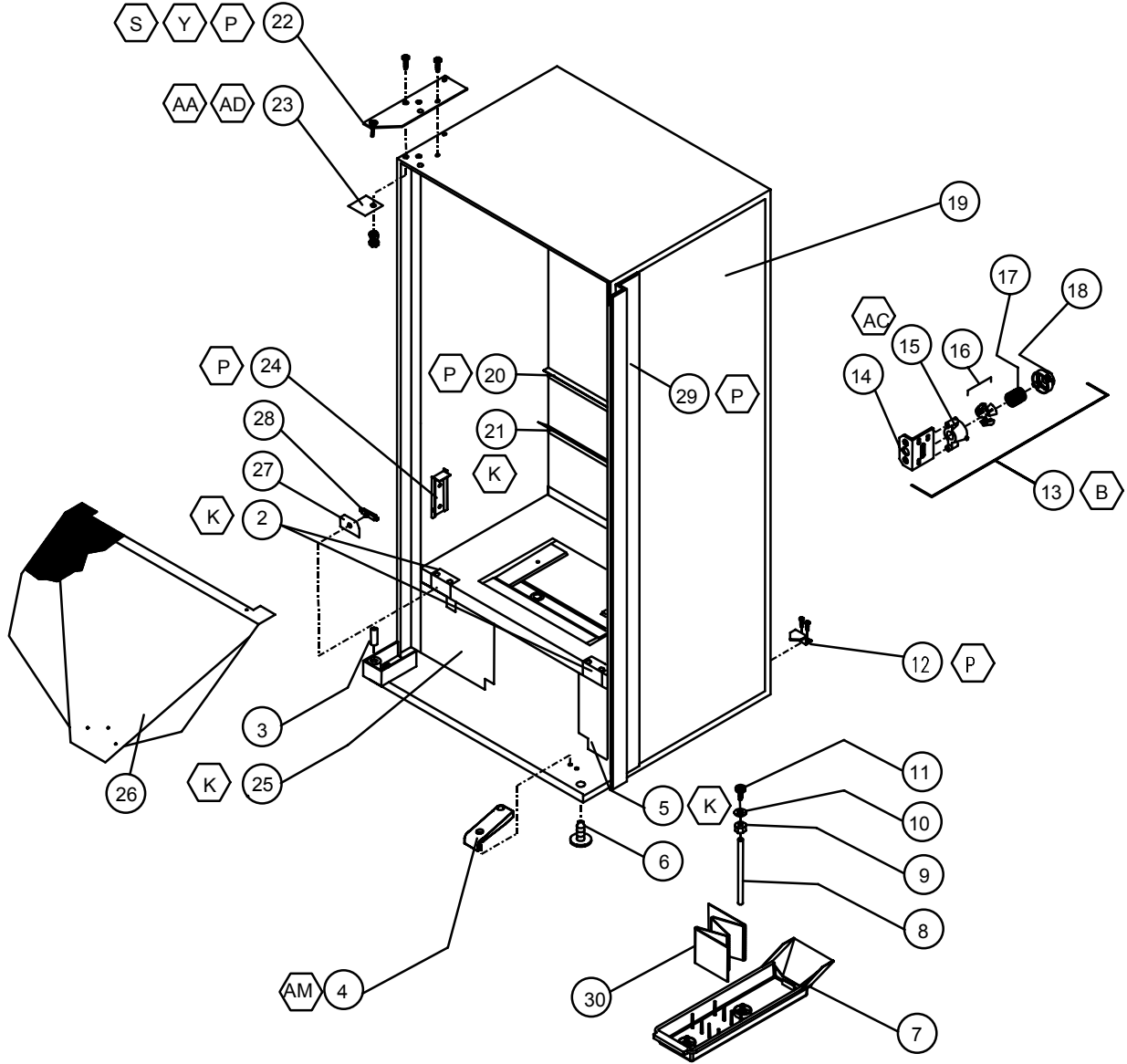



V-MAX CABINET ASSEMBLY

ITEM NO.	DESCRIPTION	QTY REQ	PART NO.
1	CABINET ASSEMBLY - FOAMED	1	*
2	CLOSURE BRACKET	2	1078791
3	HINGE PIN	1	389071
4	RAMP	1	1120387
5	AIR DAM - RIGHT	1	1122548
6	LEVELING LEG	4	1059902
7	CONDENSATE PAN	1	1122475
8	DRAIN TUBE	1	1088449
9	NUT - DRAIN TUBE	1	387925
10	FOAM WASHER	1	387837
11	DRAIN TUBE FUNNEL	1	1068678
12	BRACKET - REFRIGERATION	2	388387
13	QUICKER LOCK ASSEMBLY	1	2010085-04
14	LATCH BRACKET	1	1079112
15	NUT RETAINER HOUSING	1	389022
16	NUT SEGMENT	3	1001477
17	SPRING	1	389690
18	CAP	1	1111988
19	SIDE DECAL	2	**
20	REAR STACK SUPPORT BRACKET	1	1079015
21	AIR BAFFLE - CABINET	1	1068023
22	TOP HINGE ASSEMBLY	1	2000805-03
23	BACKING PLATE	1	1120667
24	FRONT STACK SUPPORT BRACKET	2	1079007
25	AIR DAM ASSEMBLY (SEE PGS C16-C17)	1	--
26	PRODUCT CHUTE ASSEMBLY	1	1121926
~	PRODUCT CHUTE ASSEMBLY (MODEL 576)	1	1121926-1
27	DOOR SWITCH BRACKET	1	1121043
28	DOOR SWITCH	1	323007
29	OVERLAPPING DOOR GUARD - 72"	1	2001376
~	OVERLAPPING DOOR GUARD - 79"	1	2002325
30	FIBERGLASS EVAPORATION BOARD	1	1122728
31	AIR DAM BRACKET (NOT SHOWN)	1	1112112
32	LOWER HINGE BRACKET (NOT SHOWN)	1	1121924

*NOTE: WHEN ORDERING CABINET ASSEMBLY, PLEASE PROVIDE **9-CODE** OR **11-CODE** AND **MANUFACTURER'S DATE CODE**.

NOTE: WHEN ORDERING DECALS, PLEASE PROVIDE **STYLE.

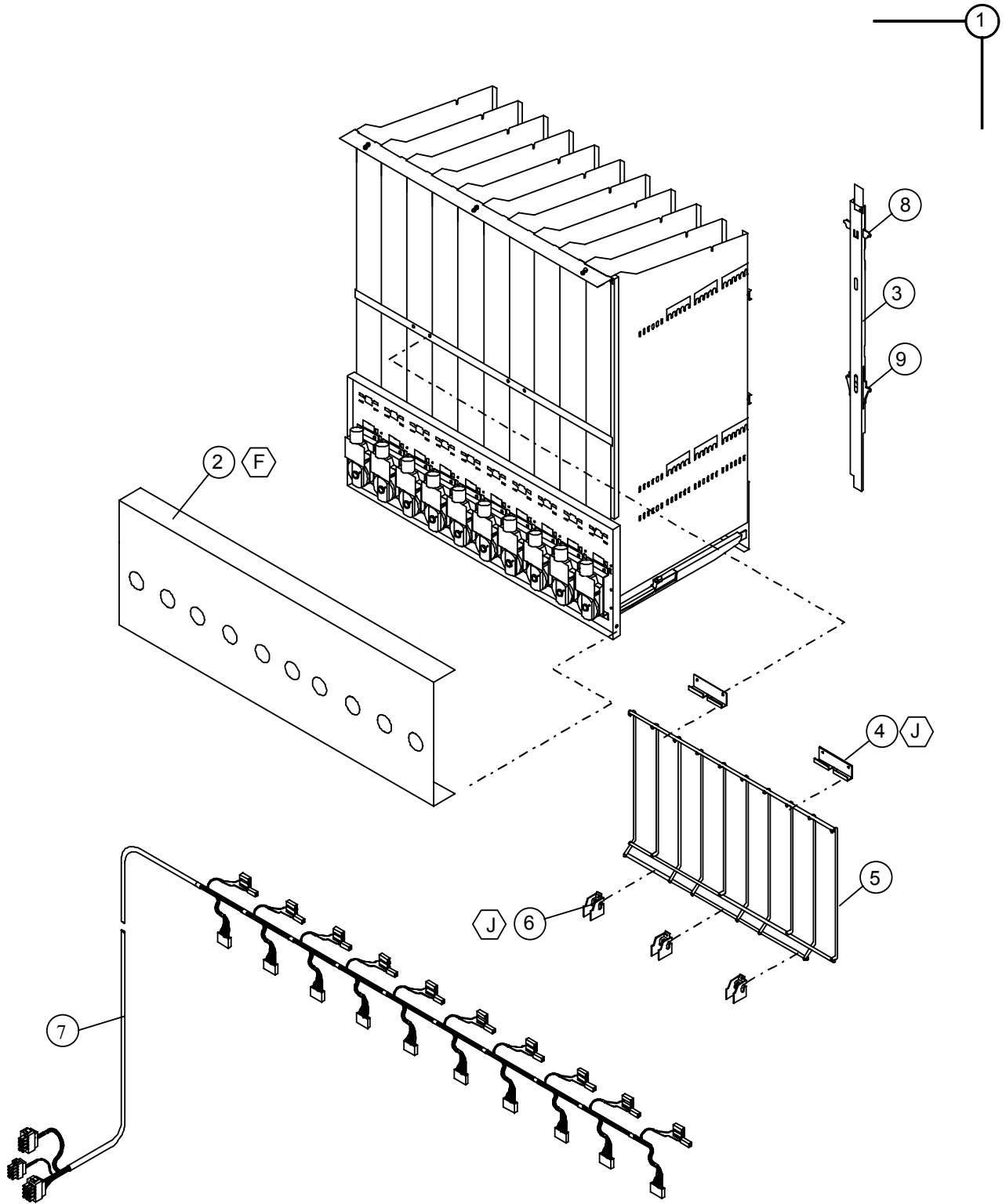



V-MAX STACK ASSEMBLY

ITEM NO.	MODEL NUMBER		GIV	576	720	840	512/680	603/800
	DESCRIPTION	QTY REQ	PART NO.	PART NO	PART NO.	PART NO.	PART NO.	PART NO.
1	STACK CHASSIS ASSEMBLY	1	1112694-01	1112694-03	1112694-01	1112694-02	1005219-102	1005219-103
2	MECH COVER	1	1076634	1117724	1076634	1076634	1076634	1076634
3	BACK SPACER ASSEMBLY	10	2009473-01	2009473-01	2009473-01	2009473	2009473-02	2009473-03
4	HOOK RACK RETAINER	2	1086813	1086813	1086813	1086813	1086813	1086813
5	LOADING RACK / PRODUCT RETAINER	1	1086805-1	1117848	1086805-1	1086805-1	1086805-1	1086805-1
6	BRKT - LOADING RACK	3	1120095	1120095	1120095	1120095	1120095	1120095
7	MOTOR HARNESS	1	1120138	1117856	1120138	1120138	1120138	1120138
8	HANGER -TOP	1	1120489	1120489	1120489	1120489	1120489	1120489
9	HANGER - BOTTOM	1	1120490	1120490	1120490	1120490	1120490	1120490

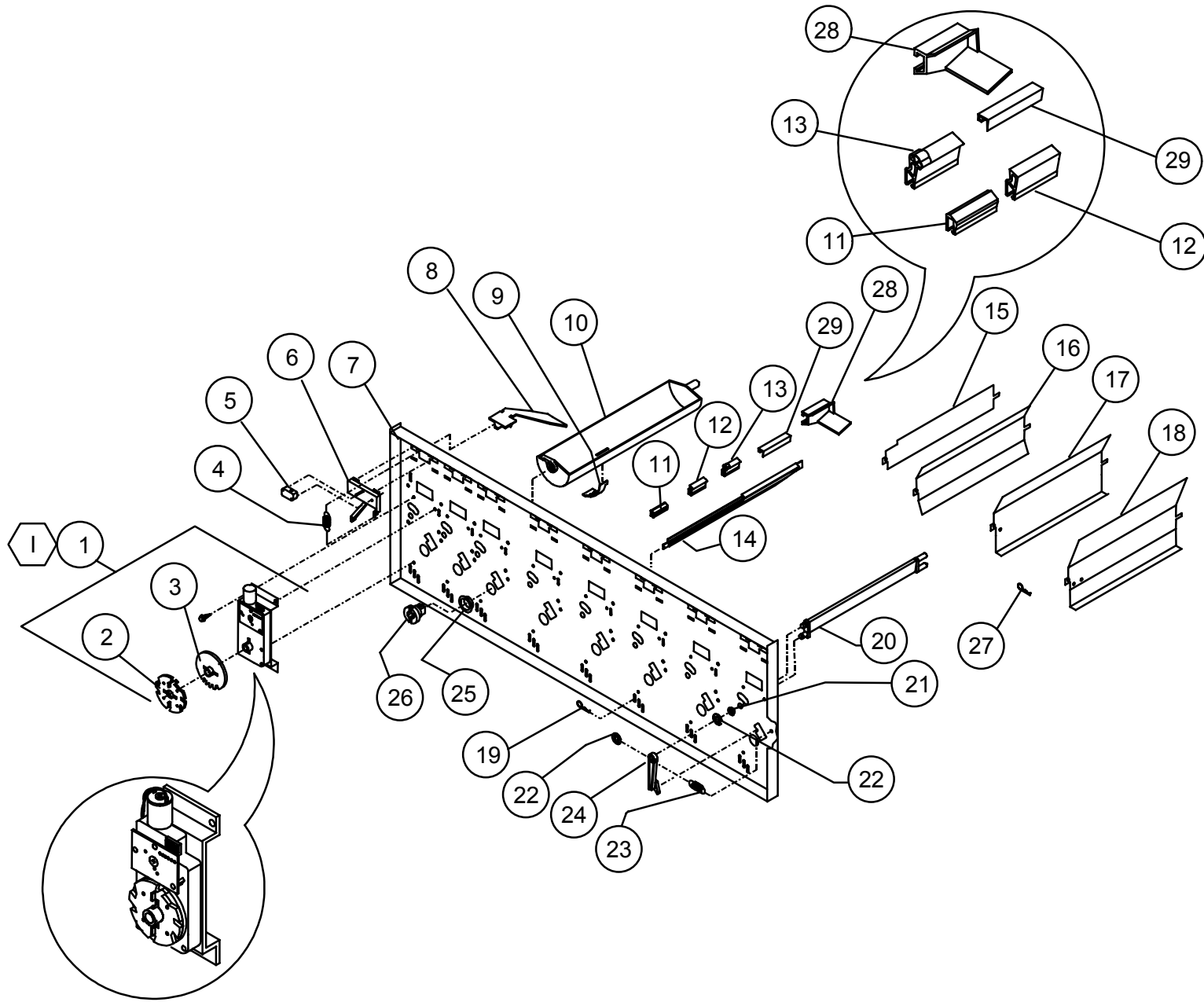



V-MAX STACK ASSEMBLY

ITEM NO.	MODEL NUMBER		GIV	576	720/840
	DESCRIPTION	QTY REQ	PART NO.	PART NO.	PART NO.
1	VEND MOTOR ASSEMBLY	10	1115821	1115821	1115821
2	RETAINER - CAM	1	1113244	1113244	1113244
3	TIMING CAM	1	1113236	1113236	1113236
4	SPRING	10	390326	390326	390326
5	SWITCH - SOLD-OUT	10	368299	368299	368299
6	SWITCH MOUNT - SOLD-OUT	10	1120037	1120037	1120037
7	FRONT MECH PLATE	1	1079023	1117678	1079023
8	SOLD-OUT LEVER - LONG	10	1112163	1112163	1112163
9	ANTI THEFT CLIP	40	389712	389712	389712
10	VEND BUCKET	10	1120146	1120146	1120146
11	* CLIP - SEE PRODUCT SET-UP GUIDE (SHORT - WHITE)	AR	1066104	1066104	1066104
12	* CLIP - SEE PRODUCT SET UP GUIDE (MEDIUM - GREY)	AR	1066112-1	1066112-1	1066112-1
13	* CLIP - SEE PRODUCT SET-UP GUIDE (TALL - BLACK)	AR	1066112	1066112	1066112
14	GAGE BAR	10	1111651	1111651	1111651
15	* PRODUCT SPACER - FLAT .06	AR	1078848	1078848	1078848
16	*PRODUCT SPACER - 0.27	AR	1122032	1122032	1122032
17	* PRODUCT SPACER - 0.37	AR	1078864	1078864	1078864
18	* PRODUCT SPACER - 0.47	AR	1078872	1078872	1078872
19	COTTER CLIP - GAGE BAR	10	387450	387450	387450
20	GATE	10	1121282	1121282	1121282
21	BEARING - GATE (FRONT & REAR)	20	385603-5	385603-5	385603-5
22	E-CLIP - GATE	20	388589	388589	388589
23	SPRING	10	387849	387849	387849
24	GATE LINK	10	1120140	1120140	1120140
25	BUSHING - VEND BUCKET (FRONT & REAR)	20	1008706	1008706	1008706
26	MOTOR COUPLING	10	1076465	1076465	1076465
27	COTTER CLIP - SPACER	1	1032526	1032526	1032526
28	FOUR-DEEP CLIP	AR	1122103	1122103	1122103
29	3 RD CAN CLIP	AR	1121704	1121704	1121704

* NOTE: DEPENDING ON PRODUCT SET-UP

** NOTE: ALL 576 MODELS WILL ONLY HAVE EIGHT COMPONENTS

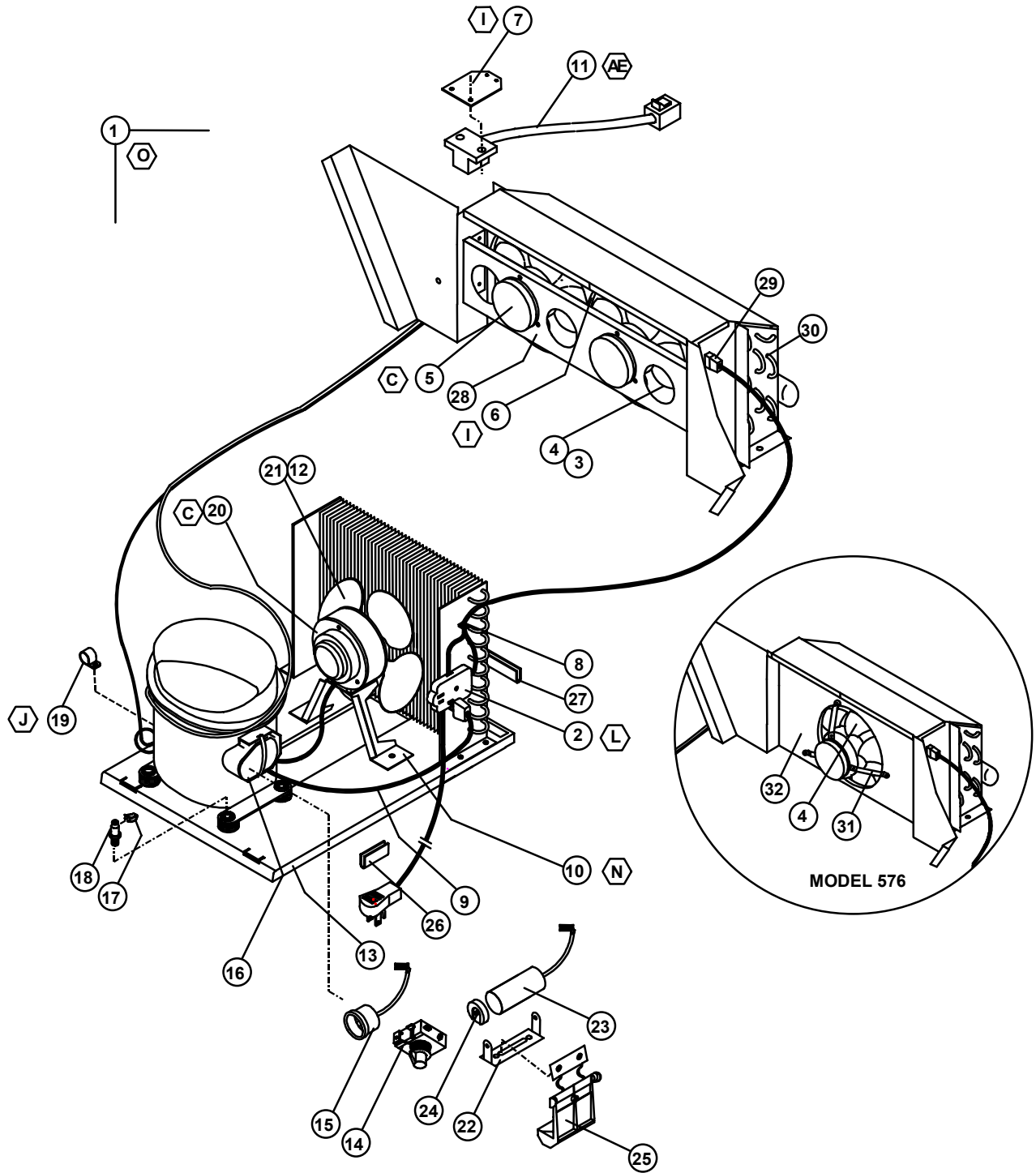



V-MAX REFRIGERATION ASSEMBLY

ITEM NO.	DESCRIPTION	QTY REQ	110V PART NO.
1	REFRIGERATION ASSEMBLY D90	1	1120341
2	SERVICE PLUG ASSEMBLY US	1	1120617
3	FAN CLIP - EVAPORATOR	2	336640
4	FAN BLADE	2	1113562
5	EVAPORATOR FAN MOTOR	2	42321-17
6	ORIFICE PLATE - EVAPORATOR FAN	1	1120571
7	BRACKET TEMP SENSOR	1	1121777
8	CLAMP PUSH MOUNT	1	384692-3
9	COMPRESSOR CORD	1	1121020
10	BRACKET - CONDENSER FAN	1	389797
11	TEMP SENSOR	1	1121777
12	FAN CLIP - CONDENSER	1	V42323
13	BASE - REFRIGERATION	1	1122470
14	START RELAY (INCLUDED IN ASSEMBLY 513506066)	1	--
15	OVERLOAD PROTECTOR (INCLUDED IN ASSEMBLY 513506066)	1	--
16	COVER - OVERLOAD (INCLUDED IN ASSEMBLY 513506066)	1	--
17	CLIP - COMPRESSOR MOUNT	4	336640
18	STUD COMPRESSOR MOUNT	4	390102
19	CLAMP	1	324099-3
20	FAN MOTOR - CONDENSER	1	42321-36
21	FAN BLADE - CONDENSER	1	320766
22	BRACKET - CAPACITOR (INCLUDED IN ASSEMBLY 1112805)	1	--
23	CAPACITOR (INCLUDED IN ASSEMBLY 1112805)	1	--
24	END CAP - CAPACITOR (INCLUDED IN ASSEMBLY 1112805)	1	--
25	CLIP - CAPACITOR	1	1076481
26	EDGE TRIM - SHORT	3	388304-1
27	EDGE TRIM - LONG	1	388304-3
28	BRACKET - FAN MOTOR	1	389797
29	EVAPORATOR HARNESS	1	1122193
30	EVAPORATOR	1	385470
31	EVAPORATOR FAN BRACKET MOUNT	3	1117996
32	ORIFICE PLATE- EVAPORATOR FAN (SINGLE)	1	390228

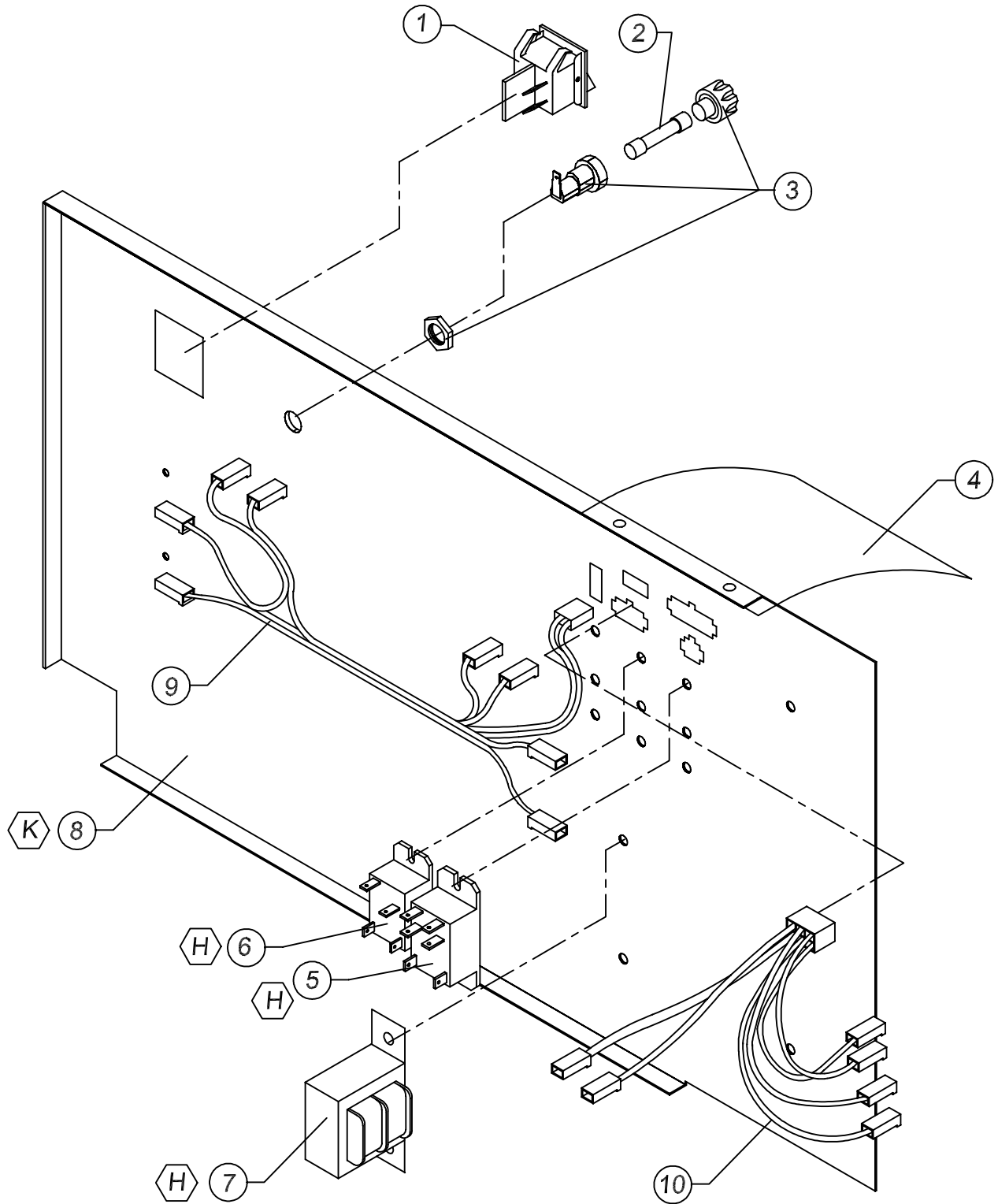



V-MAX AIR DAM ASSEMBLY

ITEM NO.	DESCRIPTION	QTY REQ	PART NO. 576	PART NO. GIV/720/840/680/800
1	SWITCH	1	1084546	1084546
2	0.8 AMP FUSE	1	1053864	1053864
3	FUSE HOLDER	1	387966	387966
4	RAIN CURTAIN	1	1121660	1121660
5	RELAY - REFRIGERATION	1	1079724	1079724
6	RELAY - LIGHT	1	1089333	1089333
7	TRANSFORMER (24 VOLT)	1	1111201	1111201
8	PANEL - AIR DAM	1	1121495	1121202
9	HARNESS - POWER	1	1110864	1110864
10	HARNESS - RELAYS AND TRANSFORMER	1	1078732	1078732



NOTES